

Article number: 0110081

Description: Retaining ring JS 68x3
Springsteel

Measures

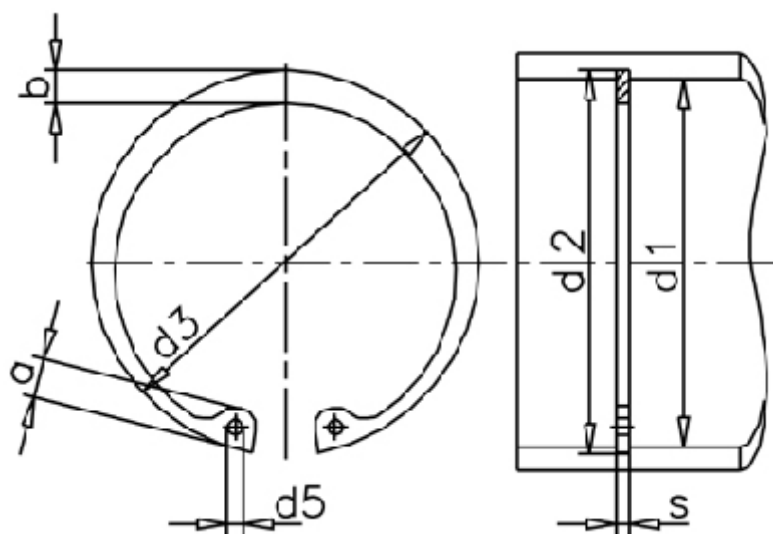

a max	= 8.8	Description	= JS 68	t	= 1.50
AN mm ²	= 327	FN kN	= 54.5	tol	= 0.30
B	= 1.44	FRg kN	= 30.6	tol	= +1,10 -0,46
b	= 6.1	FR kN	= 174.0	tol	= -0.08
d1	= 68	g	= 2.5	Tong	= ZGJ-3
d2	= 71.0	m min	= 3.15	Weight kg/1000	= 17.2
d3	= 72.5	Nominal drive	= 4.5		
d5 min	= 3.0	s	= 3.00		